



128A六轨全景推拉系统

产品简介：

尺寸：4000mm(宽)X2200mm（高）

玻璃规格：5+12A+5

表面处理：喷涂灰

用料：8.9Kg/m²

特点：

- 1: 采用隐藏式排水设计，排水孔垂直向下，斜坡设计，避免雨水倒灌，有效解决雨天出现的积水、漏水、渗水等问题
- 2: 采用多道毛条和胶条密封，提高窗的密封性能，防水，防风，防噪音，既提升房屋舒适度，又节能环保；
- 3: 扇料上部采用防摆轮和弹吊轮设计，下部采用双轨道滑轮，超大承重，使窗推拉时更加顺畅和稳定；
- 4: 整体采用平齐隐框设计，简约线条勾勒优雅风格。玻璃扇采用极简窄边设计，仅现双扇重叠位，超大视野，赋予全新的视觉享受；
- 5: 增设窗台扶手和个性化晾晒防护设计，既增加功能和美观效果，又提升防护性能。

GR128B系列高密封高排水性六轨隔热推拉窗结构图(四扇)

新河铝材
大品牌 放心用

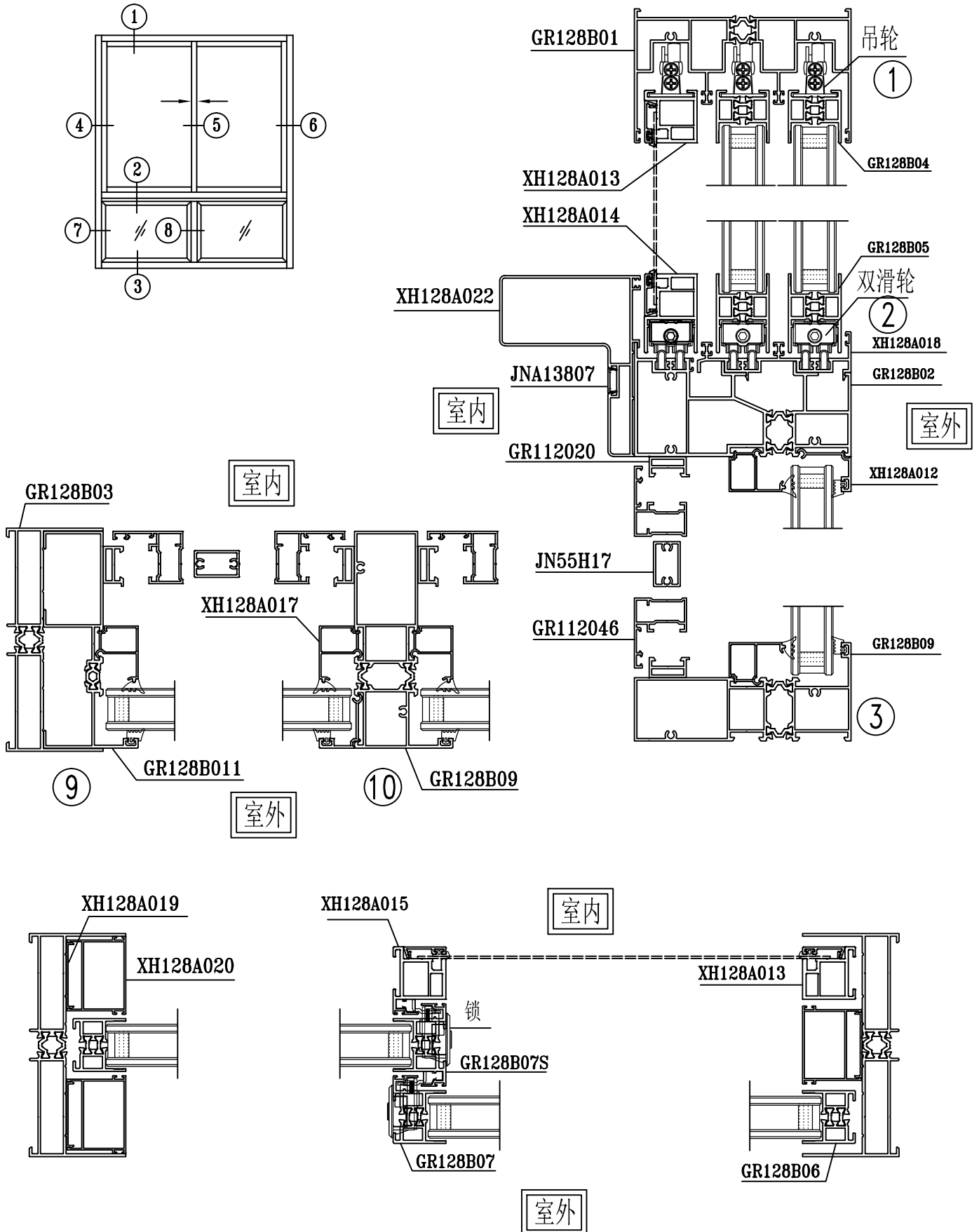

XH128A系列高密封高排水性六轨推拉窗结构图(四扇)

新河铝材
大品牌 放心用

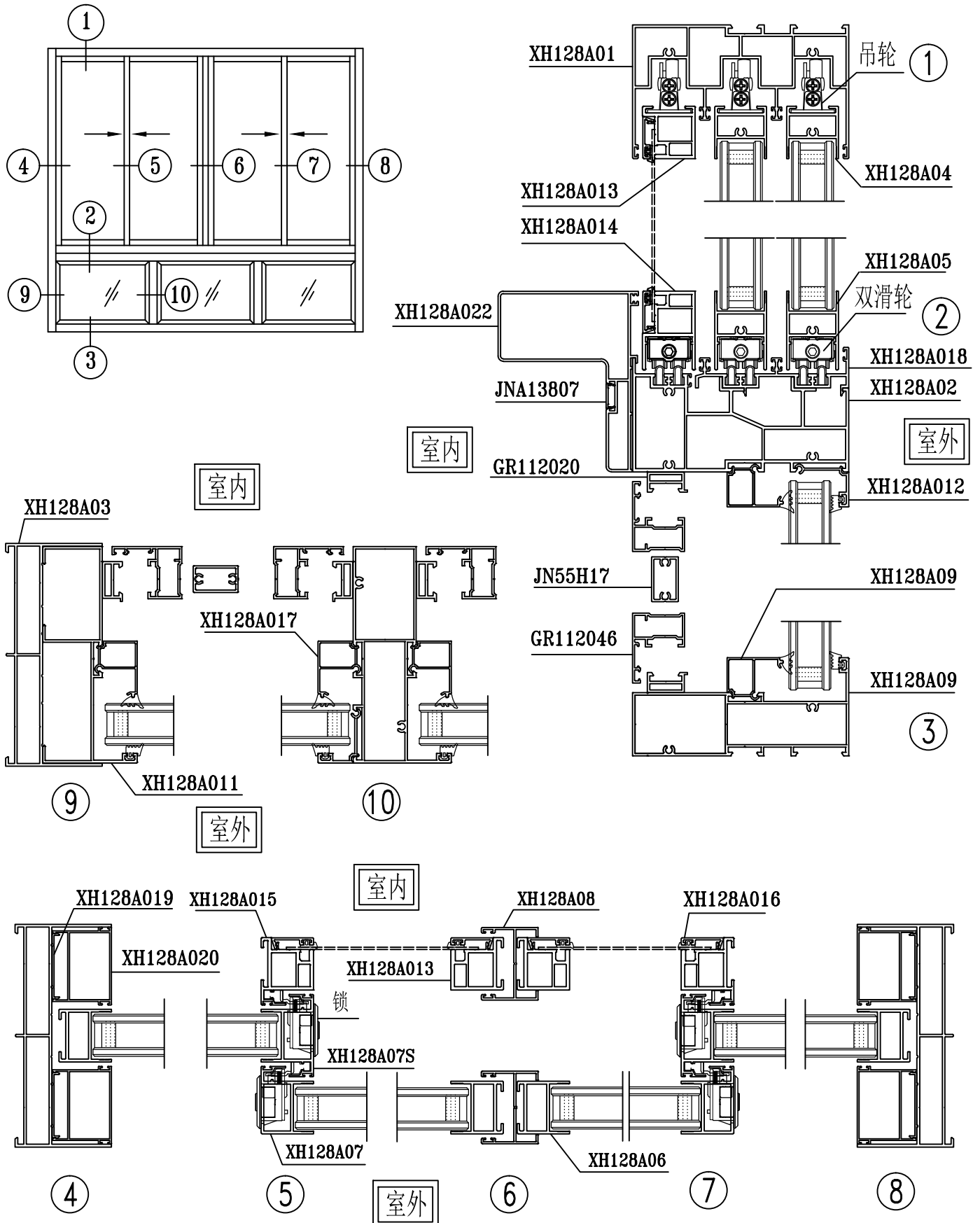

XH128A系列型材汇总

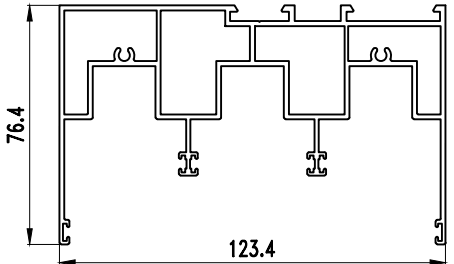
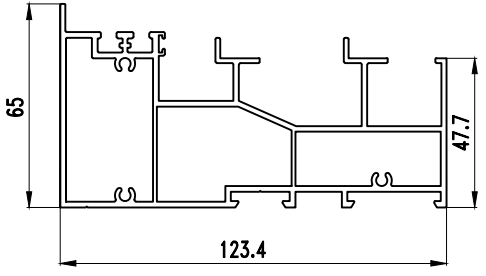
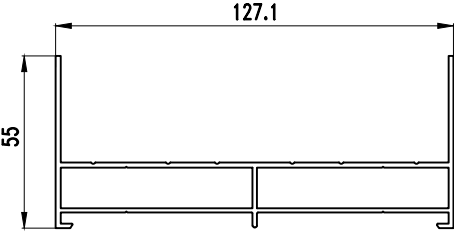
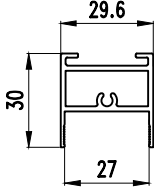
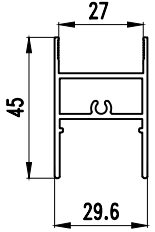
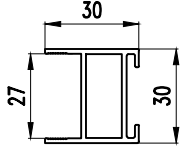
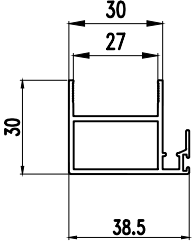
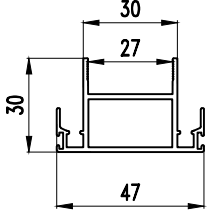
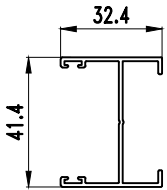
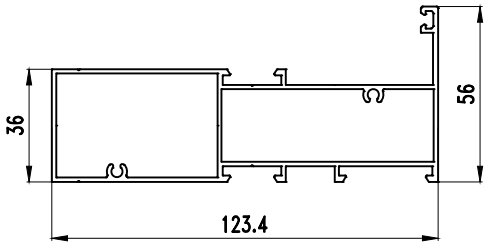
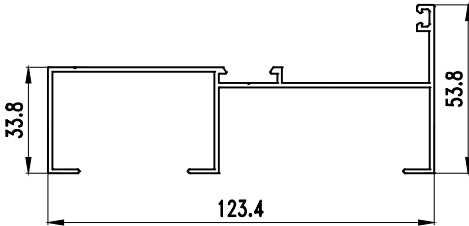
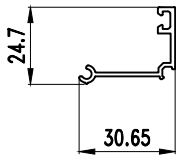
产品编号	产品图例	产品编号	产品图例
<p>XH128A01 T=1.60 mm 2.717kg/m</p>		<p>XH128A02 T=1.80 mm 2.676kg/m</p>	
<p>XH128A03 T=1.60 mm 1.583kg/m</p>		<p>XH128A04 T=1.60 mm 0.514kg/m</p>	
<p>XH128A05 T=1.60 mm 0.641kg/m</p>		<p>XH128A06 T=1.60 mm 0.514kg/m</p>	
<p>XH128A07 T=1.60 mm 0.601kg/m</p>		<p>XH128A07S T=1.60 mm 0.687kg/m</p>	
<p>XH128A08 T=1.20 mm 0.403kg/m</p>		<p>XH128A09 T=1.40 mm 1.639kg/m</p>	
<p>XH128A011 T=1.40 mm 1.094kg/m</p>		<p>XH128A012 T=1.40 mm 0.238kg/m</p>	

GR128B系列型材汇总

产品编号	产品图例	产品编号	产品图例
GR128B01 T=1.60 mm 2.744kg/m		GR128B02 T=1.80 mm 2.899kg/m	
GR128B03 T=1.60 mm 1.778kg/m		GR128B04 T=1.80 mm 0.716kg/m	
GR128B05 T=1.70 mm 0.832kg/m		GR128B07 T=1.80 mm 0.802kg/m	
GR128B07S T=1.80 mm 0.888kg/m		GR128B08 T=1.40 mm 0.931kg/m	
GR128B09 T=1.40 mm 2.009kg/m		GR128B011 T=1.40 mm 1.265kg/m	

XH128A系列型材汇总

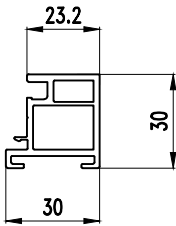
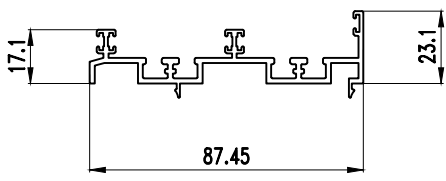
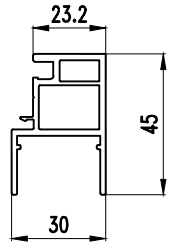
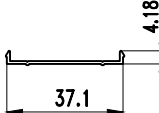
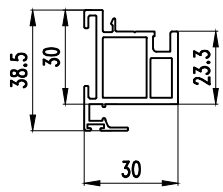
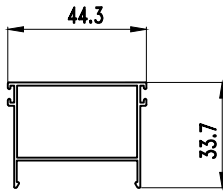
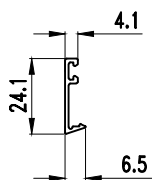
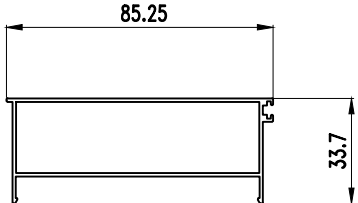
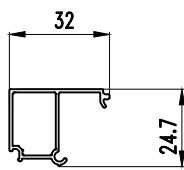
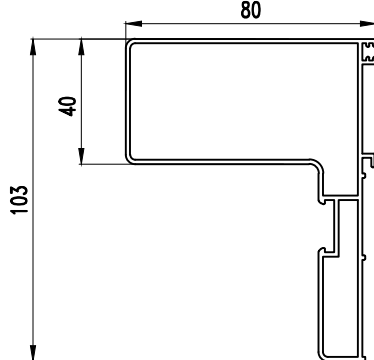
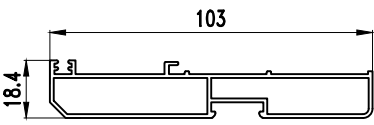
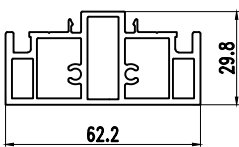
产品编号	产品图例	产品编号	产品图例
XH128A013 T=2.00 mm 0.690kg/m		XH128A018 T=1.60 mm 0.939kg/m	
XH128A014 T=2.00 mm 0.807kg/m		XH128A019 T=1.00 mm 0.120kg/m	
XH128A015 T=2.00 mm 0.776kg/m		XH128A020 T=1.00 mm 0.424kg/m	
XH128A016 T=1.10 mm 0.118kg/m		XH128A021 T=1.10 mm 0.726kg/m	
XH128A017 T=1.00 mm 0.275kg/m		XH128A022 T=1.40 mm 1.477kg/m	
XH128A023 T=1.20 mm 0.882kg/m		XH128A024 T=2.0 mm 1.411kg/m	

XH128A系列型材汇总

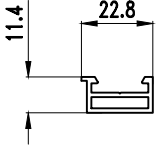
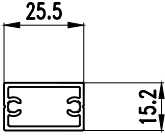
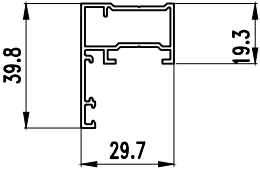
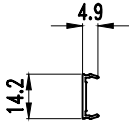
产品编号	产品图例	产品编号	产品图例
GR112020 T=1.40 mm 0.251kg/m			
JN55H17 T=1.30 mm 0.324kg/m			
GR112046 T=1.20 mm 0.459kg/m			
JNA13807 T=1.0 mm 0.061kg/m			



GR131高密侧压推拉系统

产品简介：

尺寸：2400mm(宽)X2600mm（高）

玻璃规格：5+20A+5

表面处理：喷涂

用料：9.0Kg/m²

特点：

- 1: 超大全景玻璃落地窗，整扇侧滑，单扇最大可达尺寸1430mm宽*3000mm高，整体承重200KG；
- 2: 高排水结构设计，解决多雨水难题，6mm平移侧压，360°多点锁闭，推拉开启，媲美平开窗的气密性；
- 3: 双轨道+静音滑轮、齿条式连接，传动精准、稳定，超强抗风压设计，防止因风力过大脱轨；
- 4: 开启方式灵活多样，单开、对开均可实现，搭配新合高端表面，产品绿色环保，隔热效果一流；
- 5: 超国标壁厚加强型材，适用于厨房、客厅、阳台、卧室等多种家居场景。

GR131系列隔热侧压窗

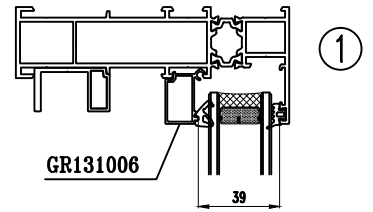
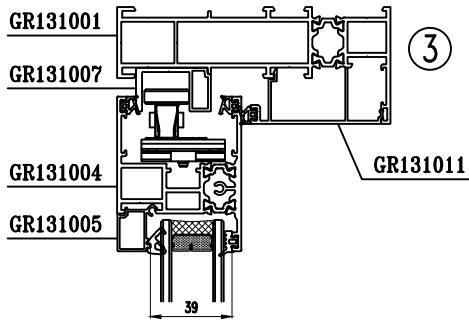
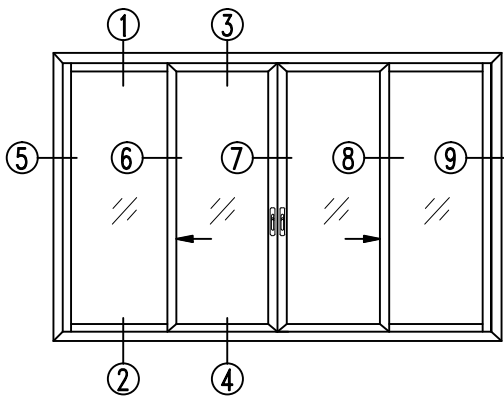

室内

室外

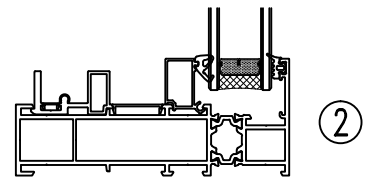
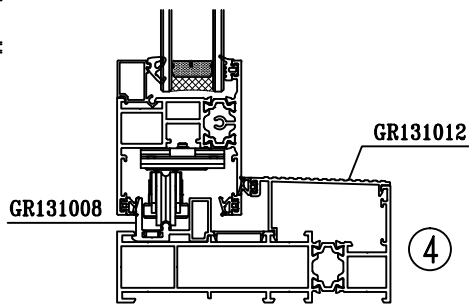
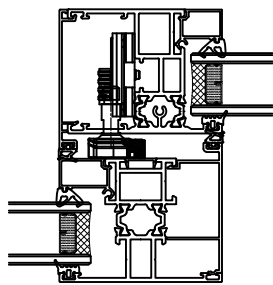
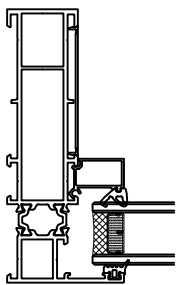

5

6

4

2

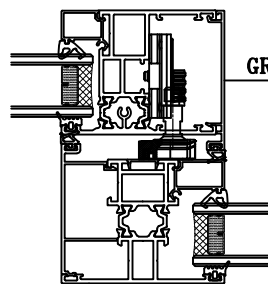
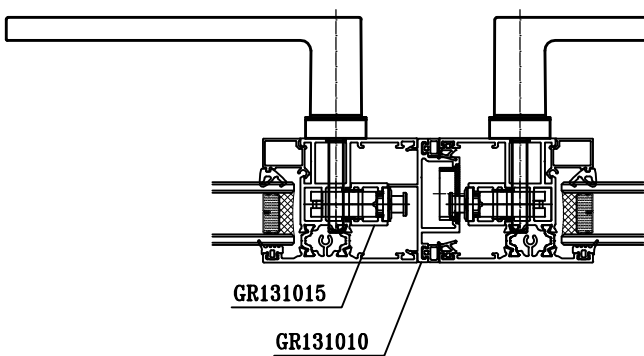

GR131014

GR131013

GR131015

GR131010

GR131003

7

8

9

室外

表1

GR131系列型材汇总

产品编号	产品图例	产品编号	产品图例
GR131001 T=2.0 mm 2.564 kg/m		GR131002 T=2.0 mm 2.681 kg/m	
GR131003 T=2.0 mm 1.685 kg/m		GR131004 T=2.0 mm 1.896 kg/m	
GR131005 T=1.0 mm 0.217 kg/m		GR131006 T=1.0 mm 0.239 kg/m	
GR131007 T=1.4 mm 0.509 kg/m		GR131008 T=1.4 mm 0.593 kg/m	
GR131009 T=2.0 mm 0.464 kg/m		GR131010 T=2.0 mm 0.686 kg/m	
GR131011 T=1.5 mm 0.477 kg/m		GR131012 T=1.5 mm 0.497 kg/m	

表2

GR131系列型材汇总

产品编号	产品图例	产品编号	产品图例
GR131013 T=1.2 mm 0.216kg/m		GR131014 T=1.3 mm 0.335kg/m	
GR131015 T=2.0 mm 0.328kg/m			

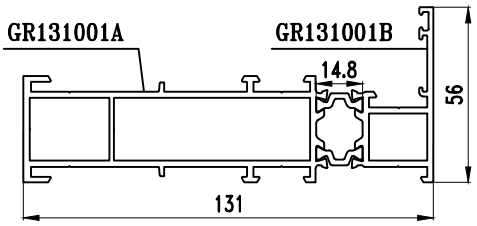
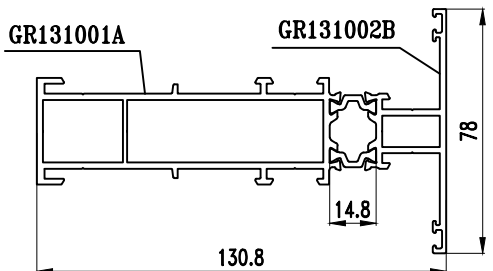
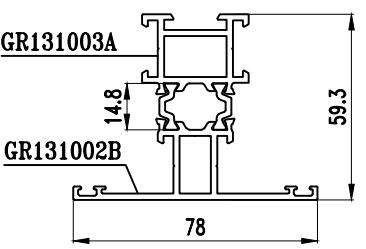
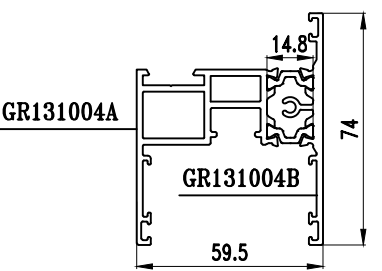
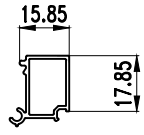
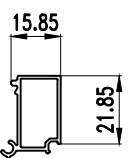
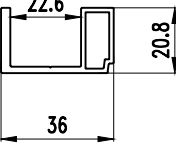
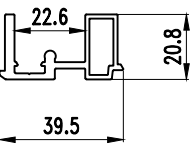
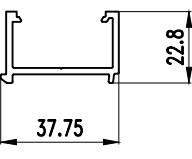
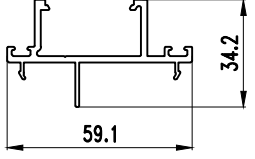
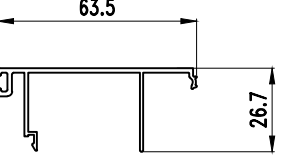
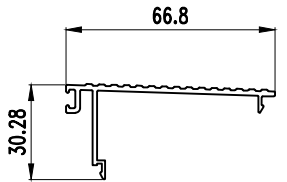
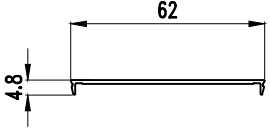
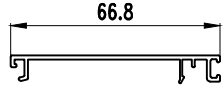
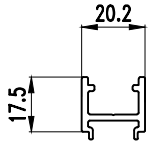

GR90-100C内倒平移系统

产品简介：

尺寸：1800mm(宽)X2200mm（高）

玻璃规格：5+20A+5

表面处理：喷涂

用料：8.6Kg/m²

特点：

- 1：外框宽度为90mm，采用30mm高强度隔热条，隔热性能优异，T=1.80mm，超高强度守护居家安全；
- 2：两种开启方式，平移开启不占用室内空间，内倒开启保持空气对流，满足更多生活开窗需求；
- 3：美狮隆隐藏式五金系统，单轨错位滑动开启，开启顺畅寿命长，密封、安全，全方位守护室内舒适生活；
- 4：独特结构与外观设计，内嵌式幕墙外观效果，固定扇与开启扇尺寸对称并与窗框齐平，完美极致；
- 5：结构性能高达国标高检测标准，能满足各种高标准的建?}需求；

GR90C内倒平移窗系列

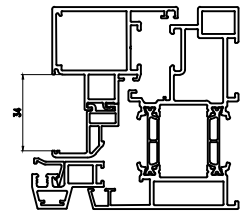
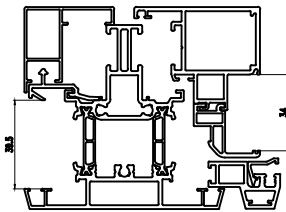
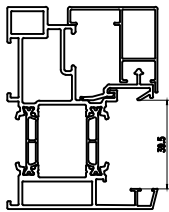
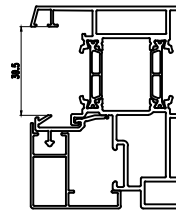
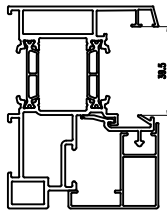
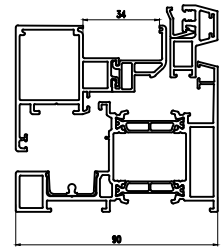
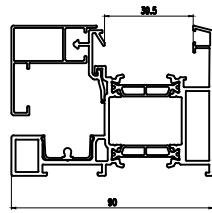
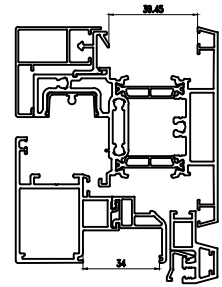
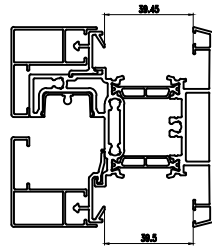
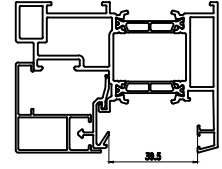
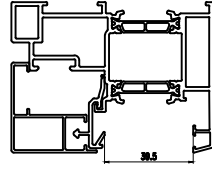
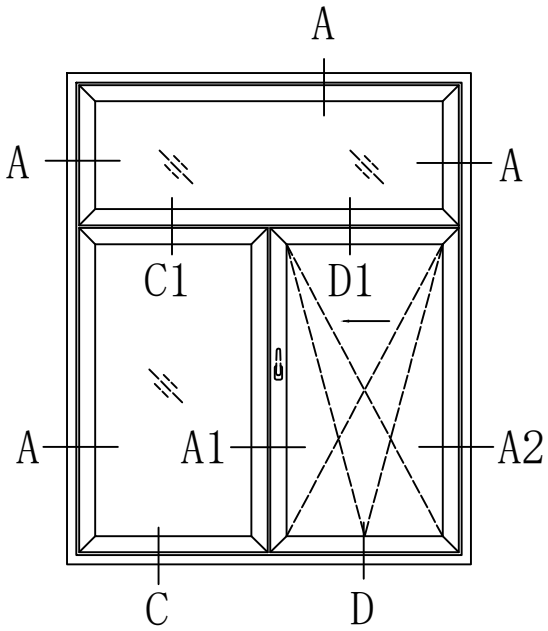

GR100C内倒平移窗系列

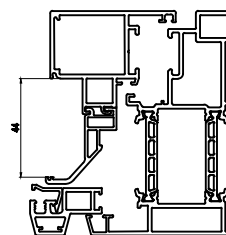
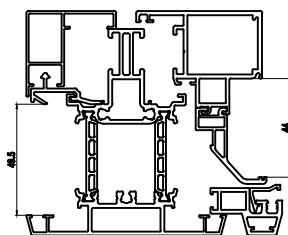
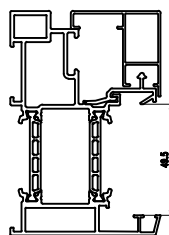
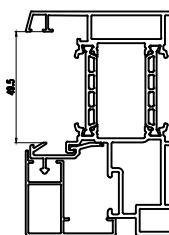
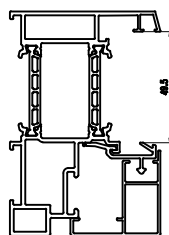
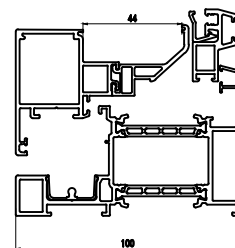
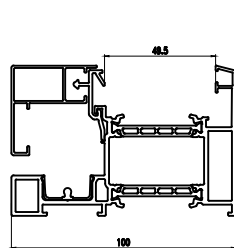
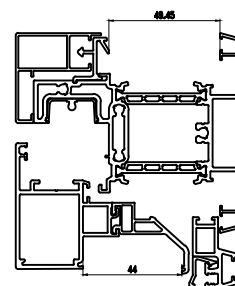
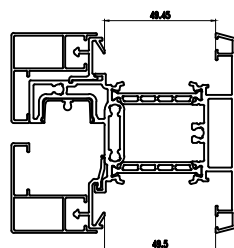
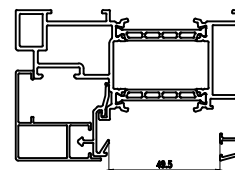
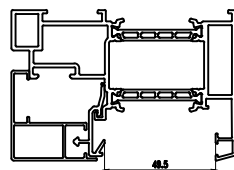
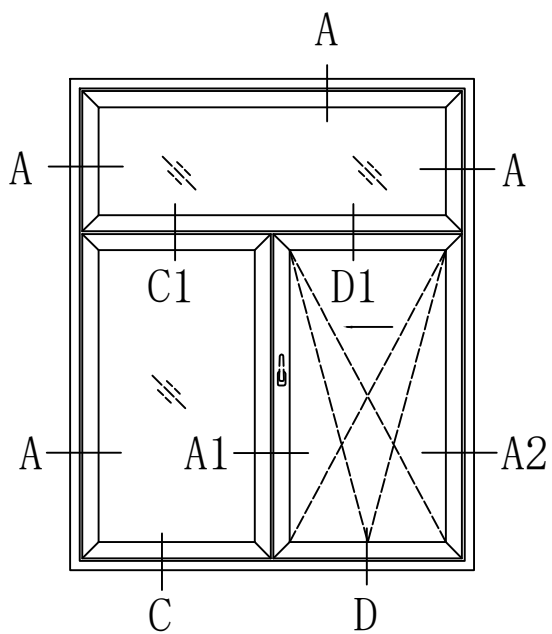

GR90/100C内倒平移窗系列

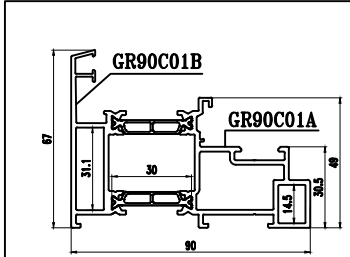

型号: GR90C01 名称: 外框
壁厚: 1.80 mm 重量: 2.052 kg/m

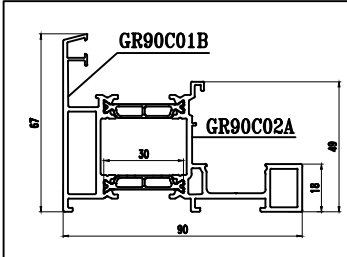

型号: GR90C02 名称: 外框
壁厚: 1.80 mm 重量: 1.886 kg/m

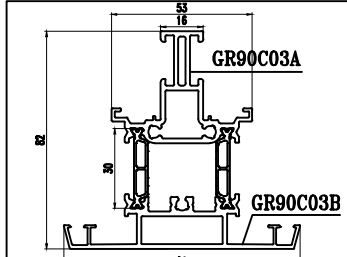

型号: GR90C03 名称: 中挺
壁厚: 1.80 mm 重量: 2.189 kg/m

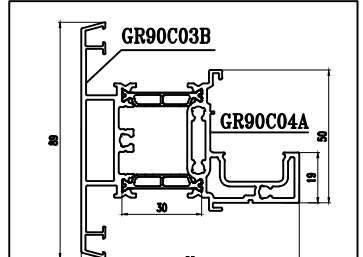

型号: GR90C04 名称: 中挺
壁厚: 1.80 mm 重量: 2.315 kg/m

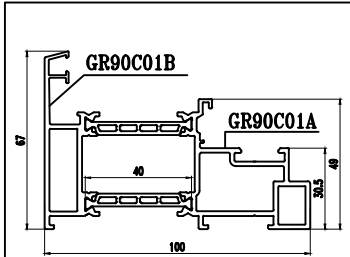

型号: GR90C13 名称: 外框
壁厚: 1.80 mm 重量: 2.202 kg/m

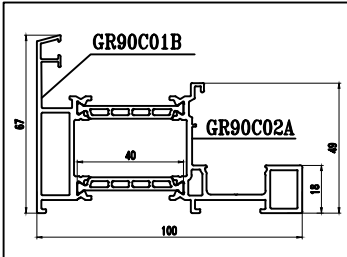

型号: GR90C14 名称: 外框
壁厚: 1.80 mm 重量: 2.036 kg/m

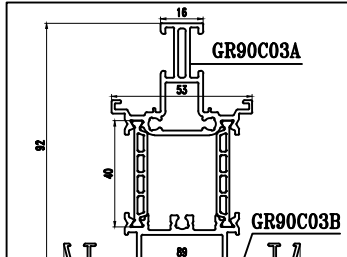

型号: GR90C15 名称: 中挺
壁厚: 1.80 mm 重量: 2.339 kg/m

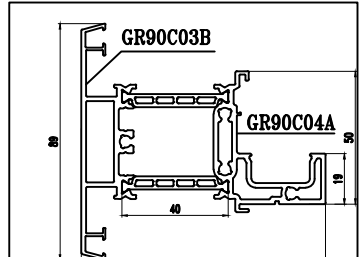

型号: GR90C16 名称: 中挺
壁厚: 1.60 mm 重量: 2.465 kg/m

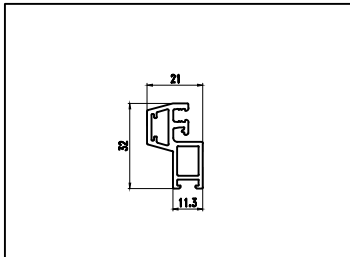

型号: GR90C05 名称: 纱扇
壁厚: 1.60 mm 重量: 0.529 kg/m

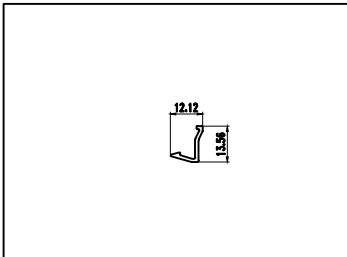

型号: GR90C06 名称: 纱扇压线
壁厚: 1.30 mm 重量: 0.088 kg/m

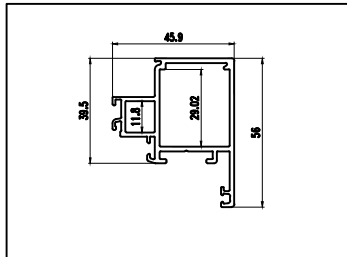

型号: GR90C07 名称: 扇料
壁厚: 1.80 mm 重量: 1.024 kg/m

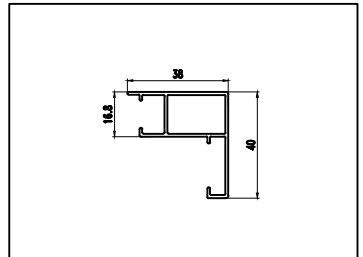

型号: GR90C08 名称: 固定压线框
壁厚: 1.10 mm 重量: 0.149 kg/m

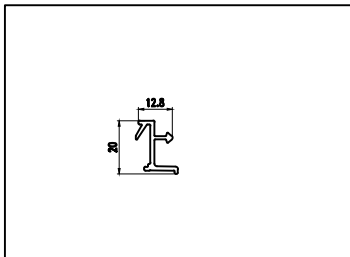

型号: GR90C09 名称: 固定横压座
壁厚: 1.50 mm 重量: 0.198 kg/m

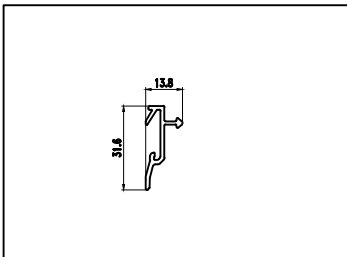

型号: GR90C10 名称: 固定压线座
壁厚: 1.50 mm 重量: 0.226 kg/m

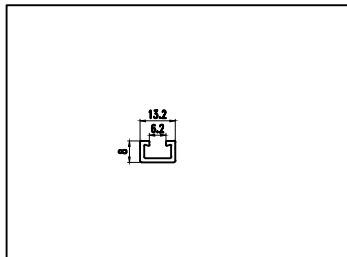

型号: GR90C11 名称: 传动杆(氧化黑)
壁厚: 1.50 mm 重量: 0.125 kg/m

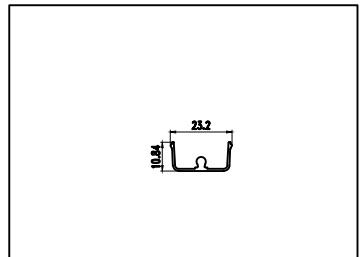

型号: GR90C12 名称: 下滑轨
壁厚: 0.80 mm 重量: 0.128 kg/m

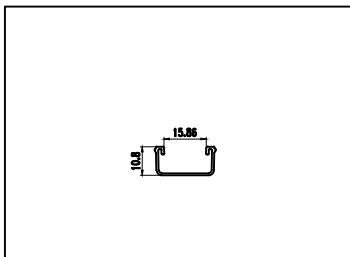

型号: KSYC8012 名称: 上滑轨
壁厚: 0.80 mm 重量: 0.114 kg/m

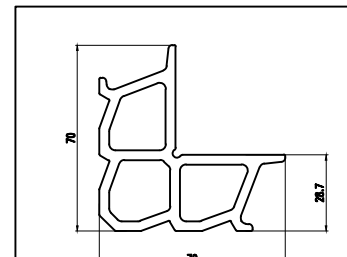

型号: KSYC8017 名称: 角码
壁厚: 3.70 mm 重量: 2.818 kg/m



M100窄边幕墙系统

产品简介：

尺寸：3000mm(宽)X3600mm（高）

玻璃规格：6+12A+6

表面处理：瓷泳香槟砂

用料：8.3Kg/m²

特点：

- 1：简约窄边设计，框内外可视面仅35mm，开启扇与外立面平齐，立面效果简洁平整；
- 2：采用6063-T6材质，主受力壁厚3.0-4.0mm，纵向深度达160mm，实现高强度，安全可靠；
- 3：多种开启方式，平推、外开、上悬，实现极简建筑室内采光、超通透景观需求与多种开启方式的完美融合
- 4：可配置平开纱窗与可拆卸式玻璃护栏，更人性化的安全与防护；
- 5：搭配新合高端表面，细腻柔和，无有害物质，安全环保，兼具颜值于才华一体。

M100窄边幕墙系统

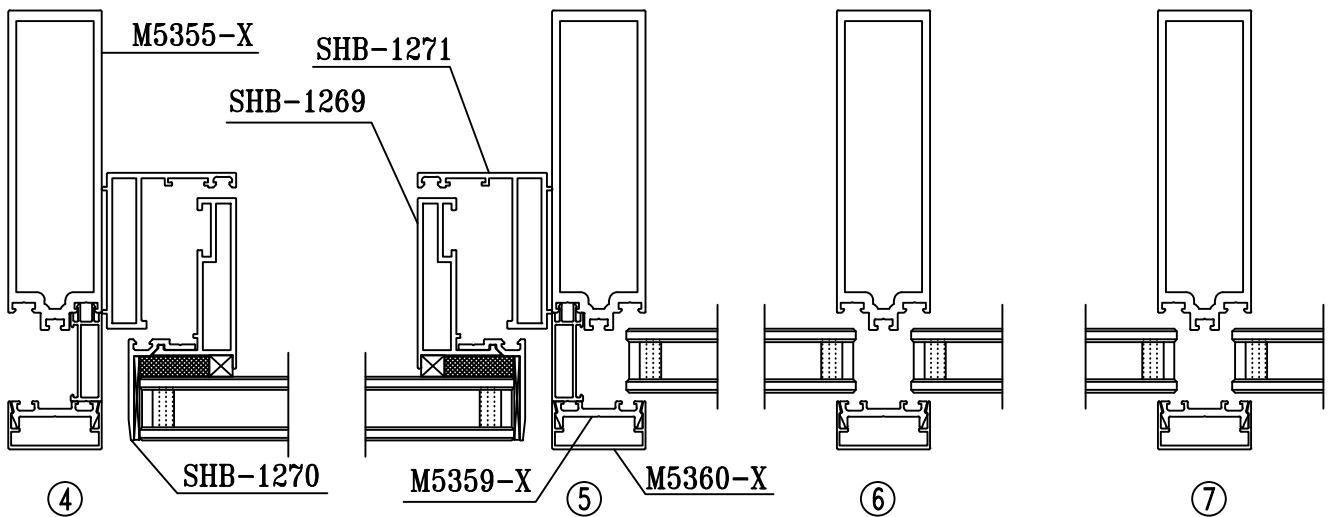
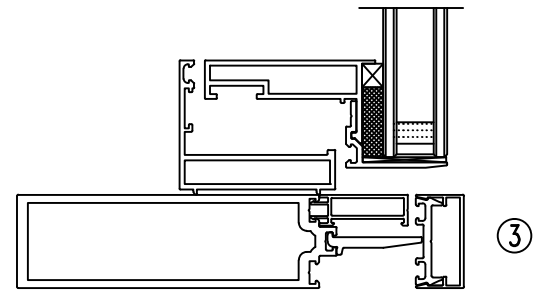
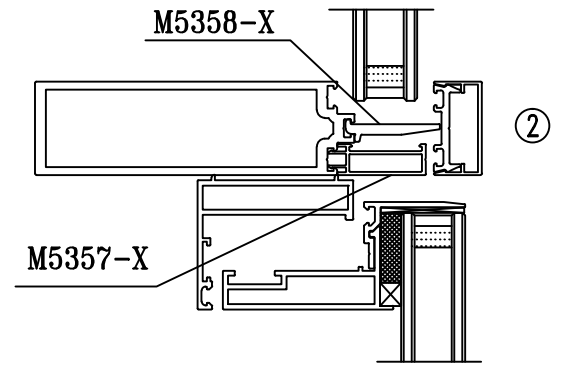
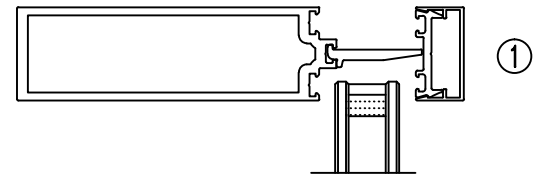
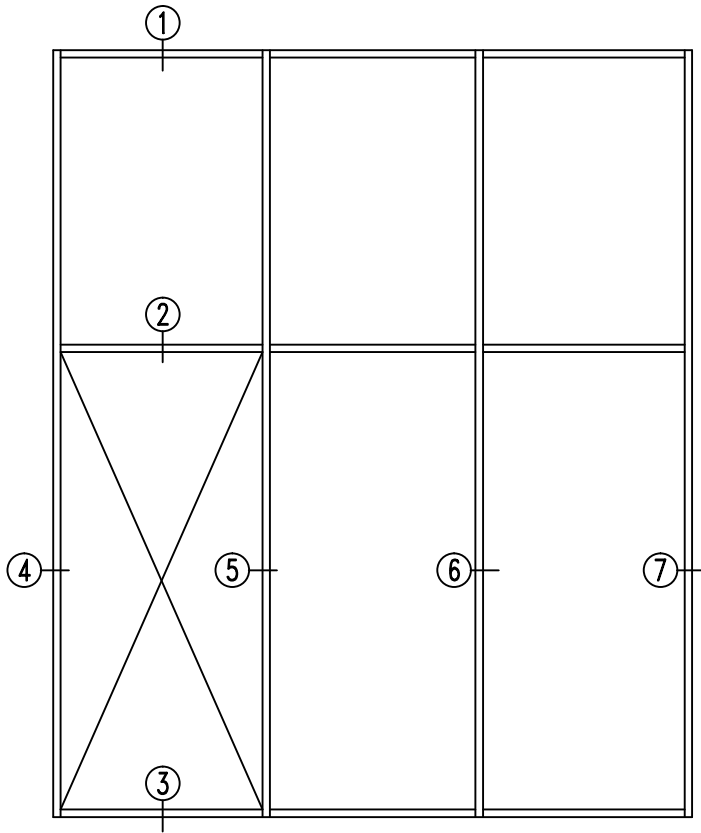

产品编号	产品图例
M5355-X T=3.0mm 2.620kg/m	
M5359-X T=3.0mm 0.336kg/m	
SHB-1270 T=2.0mm 0.357kg/m	
M5511-X T=3.0mm 2.165kg/m	
M5357-X T=1.2mm 0.317kg/m	

产品编号	产品图例
M5360-X T=1.4mm 0.248kg/m	
SHB-1269 T=2.0mm 0.934kg/m	
SHB-1271 T=2.0mm 1.012kg/m	
M5358-X T=4.0mm 0.363kg/m	



PLAA100平开窗系统

产品简介：

尺寸：1800mm(宽)X2200mm（高）

玻璃规格：6+12A+6

表面处理：喷涂

用料：7.3Kg/m²

特点：

- 1：开启扇挂钩式设计，搭配手摇式上悬五金，无坠落风险，安全可靠；
- 2：独特的胶条设计，在保证密封的同时实现框扇外立面齐平，立面效果简洁平整；
- 3：竖中梃采用单元式板块设计，提高制作效率和质量检查，可承受轻微幅度的建?}物移动，提高整体抗风压强度；
- 4：固定部位只有一条压线，幕墙式外观设计，密封性能好，美观大方；
- 5：搭配新合高端表面，细腻柔和，无有害物质，安全环保，兼具颜值于才华一体。

PLAA100平开窗系统

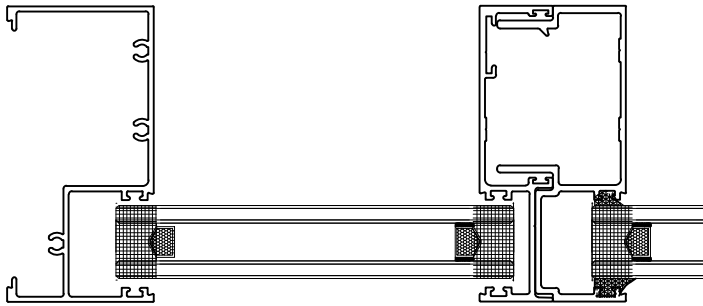
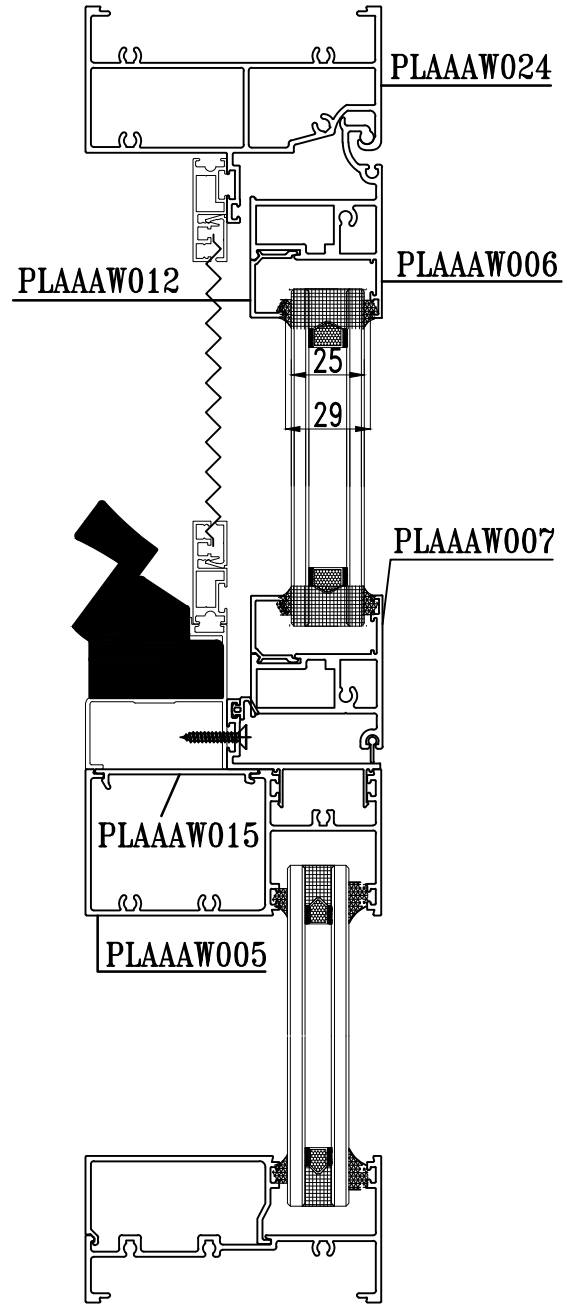
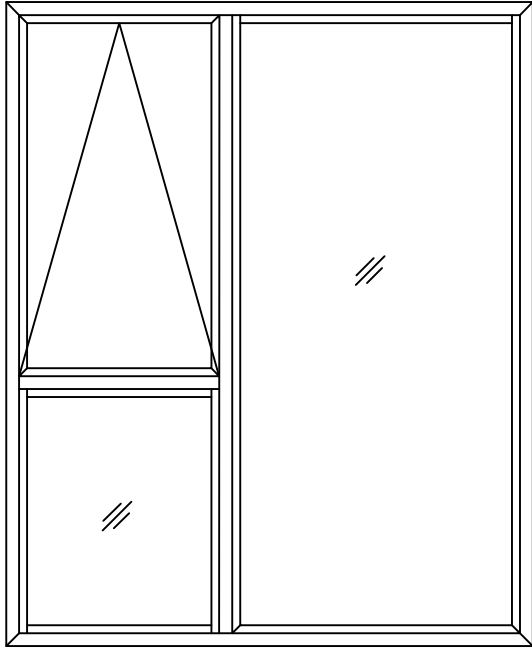

PLAAAW014

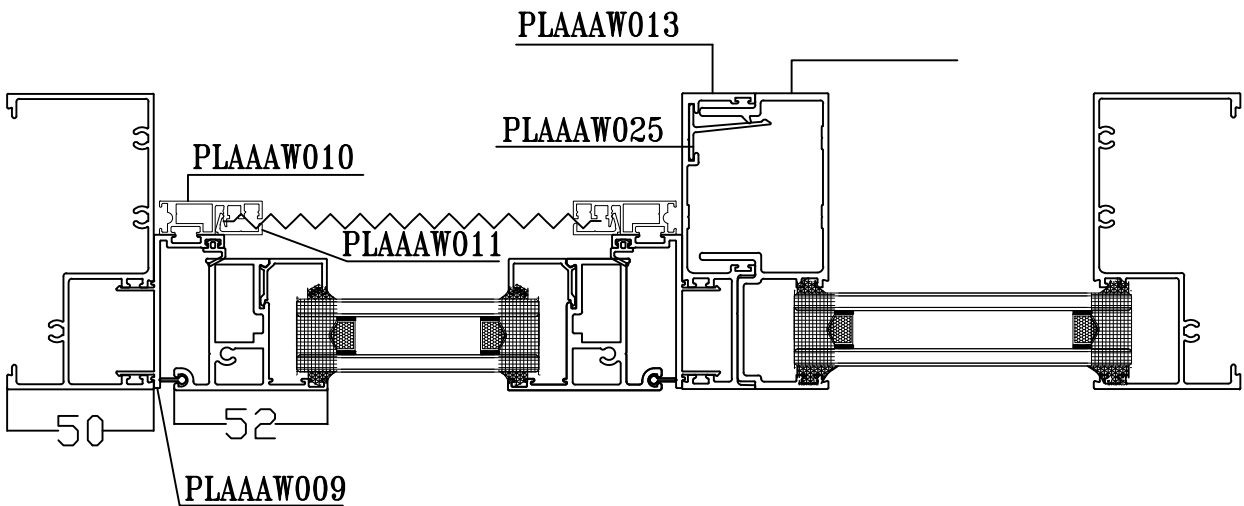

型材汇总

产品编号	产品图例	产品编号	产品图例
PLAAAW001 T=1.80 mm 1.419kg/m		PLAAAW002 T=1.80 mm 1.178kg/m	
PLAAAW003 T=1.80 mm 0.656kg/m		PLAAAW024	
PLAAAW005 T=1.80 mm 1.572kg/m		PLAAAW006 T=2.00 mm 1.302kg/m 角码配: JN65D13	
PLAAAW007 T=2.00 mm 1.112kg/m		PLAAAW008 T=1.50 mm 0.590kg/m	
PLAAAW009 T=2.00 mm 0.507kg/m		PLAAAW010 T=1.06 mm 0.318kg/m 角码配: JTL5008	
PLAAAW011 T=1.06 mm 0.075kg/m		PLAAAW012 T=1.60 mm 0.193kg/m	

型材汇总

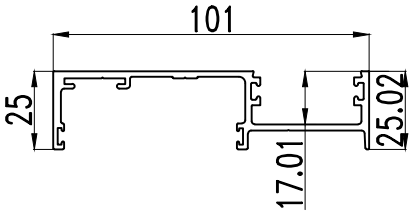
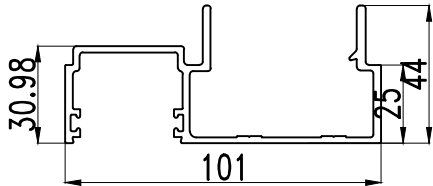
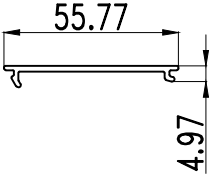
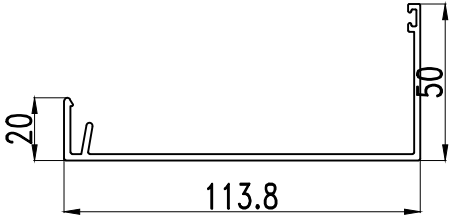
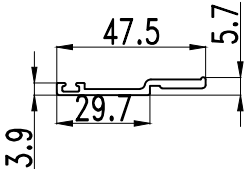
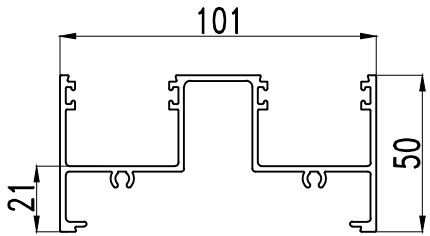
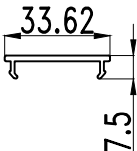
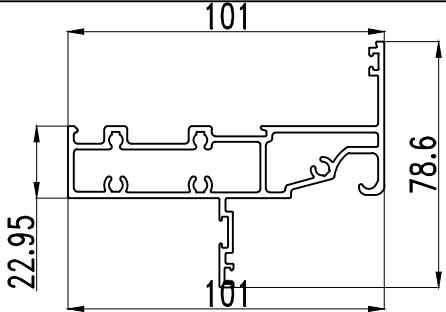
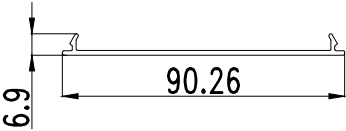
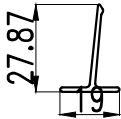
产品编号	产品图例	产品编号	产品图例
PLAAAW013 T=1.80 mm 1.099kg/m		PLAAAW014 T=2.50 mm 1.461 kg/m	
PLAAAW015 T=1.80 mm 0.308kg/m		PLAAAW016 T=2.00 mm 1.049 kg/m	
PLAAAW017 T=2.00 mm 0.316kg/m		PLAAAW018 T=1.80 mm 1.597 kg/m	
PLAAAW019 T=1.80 mm 0.206kg/m		PLAAAW020 T=1.80 mm 2.032kg/m	
PLAAAW021 T=1.55 mm 0.421 kg/m		PLAAAW025 T=1.40 mm 0.179kg/m	



120窗纱一体平开系统

产品简介:

尺寸: 1800mm(宽)X2200mm (高)

表面处理: 瓷泳香槟砂





玻璃规格: 5+20A+5

用料: 10.8Kg/m²

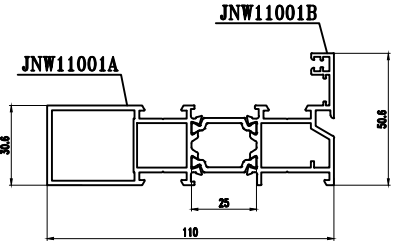
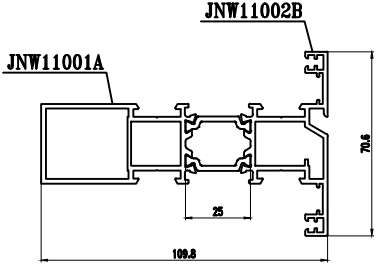
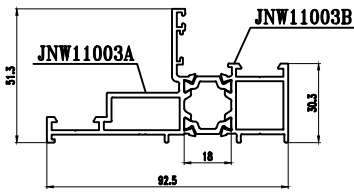
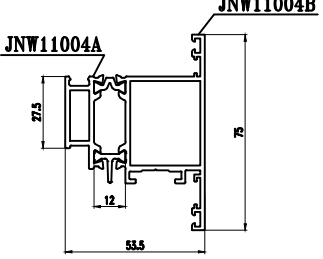
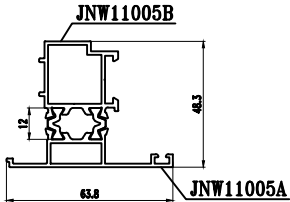
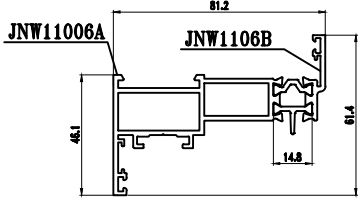
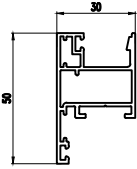

特点:

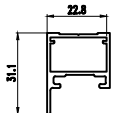
- 1: 外框宽度为120mm, 采用35.3mmPA66高强度尼龙隔热条, 隔热性能优异, T=1.80mm, 超高强度守护居家安全;
- 2: 扇料与外框齐平, 采用隐藏排水形式, 排水顺畅, 采用多道胶条密封, 气密、水密性能佳;
- 3: 纱扇与玻璃扇中间空间为44mm, 可以加装防护格, 防护格可开启, 为安全家居提供强有力保障;
- 4: 全系具有110, 120外框, 型材通用性强; 玻璃多种尺寸可选, 纱网采用金钢纱, 连接稳固牢靠, 隔音静谧, 享受舒适家居环境;
- 5: 五金配件采用欧洲标准设计, 通用性强, 客户可选性广

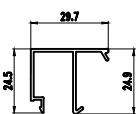
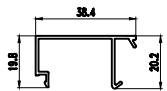
型材汇总

产品编号	产品图例	产品编号	产品图例
<p>JNW11001</p> <p>T=1.80 mm</p> <p>2.081 kg/m</p>		<p>JNW11002</p> <p>T=1.80 mm</p> <p>2.274 kg/m</p>	
<p>JNW11003</p> <p>T=1.80 mm</p> <p>1.609 kg/m</p>		<p>JNW11004</p> <p>T=1.80 mm</p> <p>1.602 kg/m</p>	
<p>JNW11005</p> <p>T=1.40 mm</p> <p>1.131 kg/m</p>		<p>JNW11006</p> <p>T=1.80 mm</p> <p>1.577 kg/m</p>	
<p>JNW11007</p> <p>T=1.30 mm</p> <p>0.707 kg/m</p>		<p>JNW11008</p> <p>T=1.20 mm</p> <p>0.093 kg/m</p>	
<p>JNW11009</p> <p>T=1.20 mm</p> <p>0.397 kg/m</p>		<p>JNW11010</p> <p>T=0.80 mm</p> <p>0.155 kg/m</p>	
<p>JNW11011</p> <p>T=1.10 mm</p> <p>0.260 kg/m</p>		<p>JNW11014</p> <p>T=1.10 mm</p> <p>0.258 kg/m</p>	

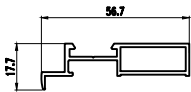
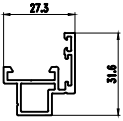
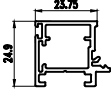
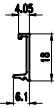
型材汇总

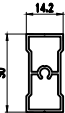
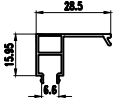
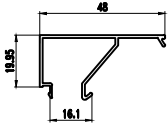
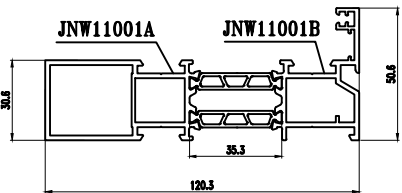
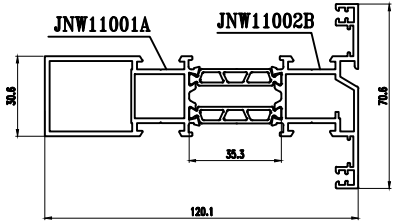
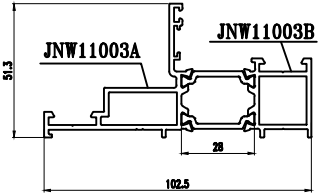
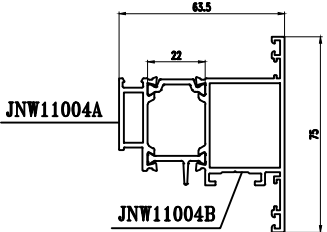
产品编号	产品图例	产品编号	产品图例
JNW11015 T=1.35 mm 0.490kg/m		JNW11016 T=1.40 mm 0.429kg/m	
JNW11017 T=1.40 mm 0.474kg/m		JNW11018 T=1.00 mm 0.077kg/m 氧化专用	
JNW11018A T=1.00 mm 0.077kg/m 喷涂专用		JNJ9058 T=1.00 mm 0.280kg/m	
JNW11010B T=0.80 mm 0.190kg/m		JNW11011A T=1.1 mm 0.327kg/m	
JNW11019 T=1.80 mm 2.193kg/m		JNW11020 T=1.80 mm 2.386kg/m	
JNW11021 T=1.80 mm 1.661kg/m		JNW11022 T=1.80 mm 1.657kg/m	



58A极窄折叠门系统

产品简介：

尺寸：3600mm(宽)X2600mm（高）

玻璃规格：5+12A+5

表面处理：喷涂

用料：8.1Kg/m²

特点：

- 1：扇料采用45°角码连接，规格为58X24mm，窄边设计，省料同时加大可视面积；
- 2：可做1+0，2+1，2+2，3+1等配置，玻璃口为26mm，满足不同使用要求；
- 3：下轨，采用双轨道、不锈钢轨设计，承重力强，耐用、推拉顺畅、不易脱色；
- 4：门扇采用隐形合页，四周胶条密封，使得产品不仅线条流畅、造型美观，而且抗震动、防噪音等性能也显著提高，还能起到防夹手功能；
- 5：适用于别墅、高档住宅、商住楼、写字楼等需大面积开启空间场所。

ZDM58A窄边折叠门系列 (431)

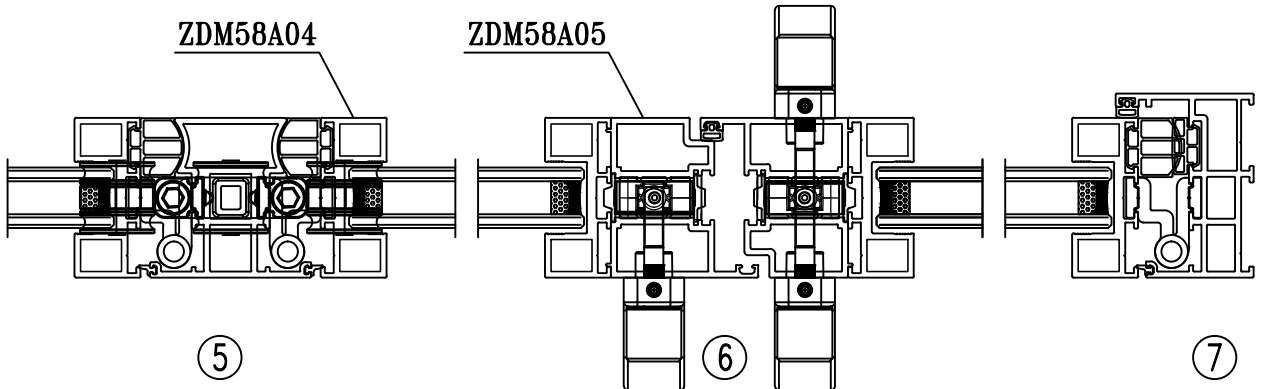
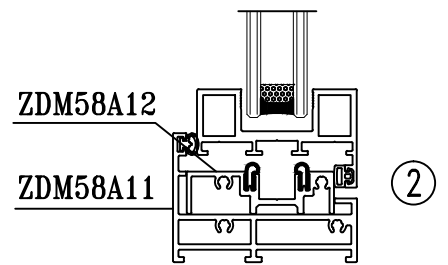
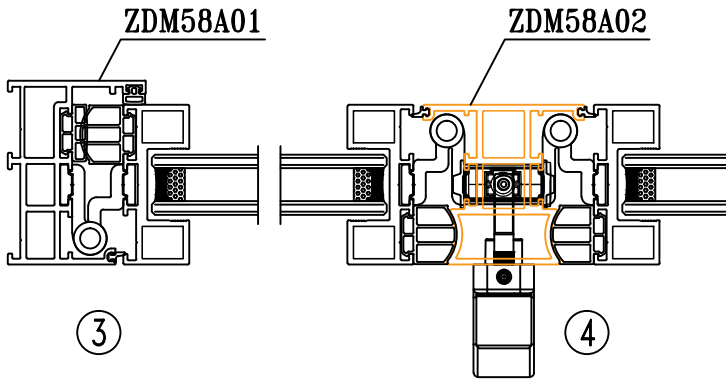
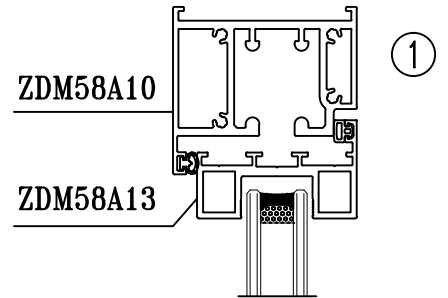
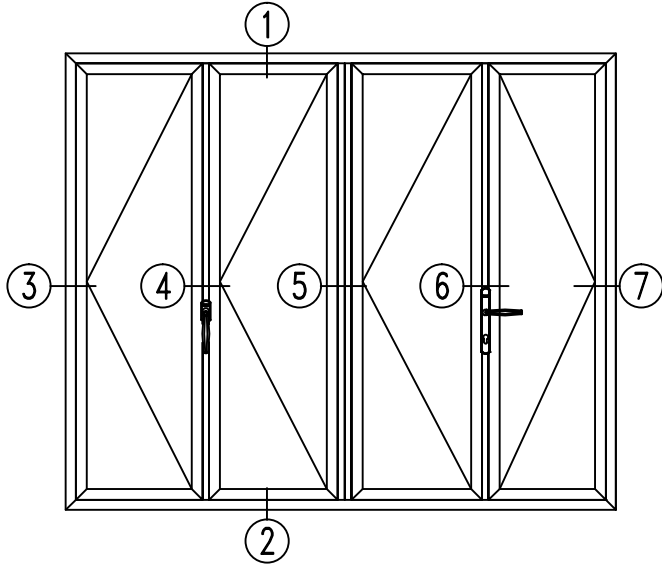

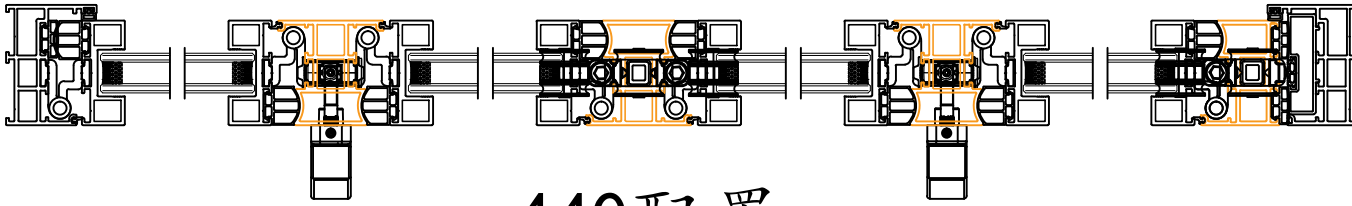

440配置

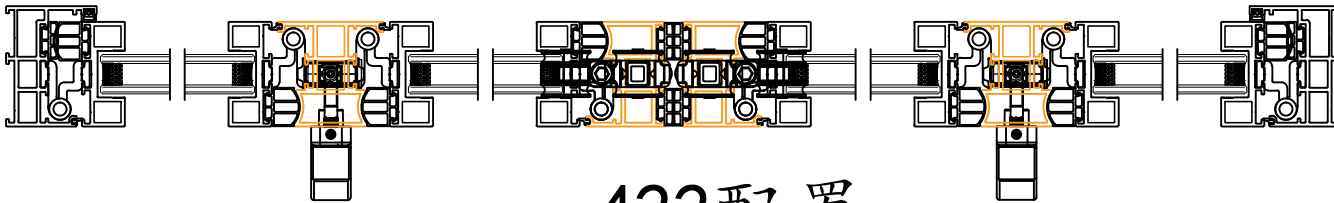

422配置

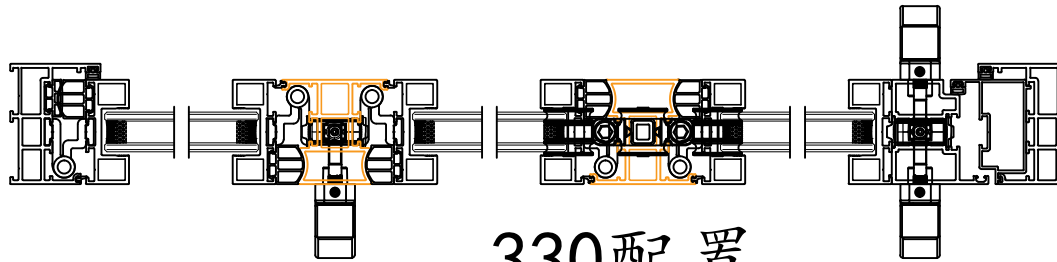

330配置

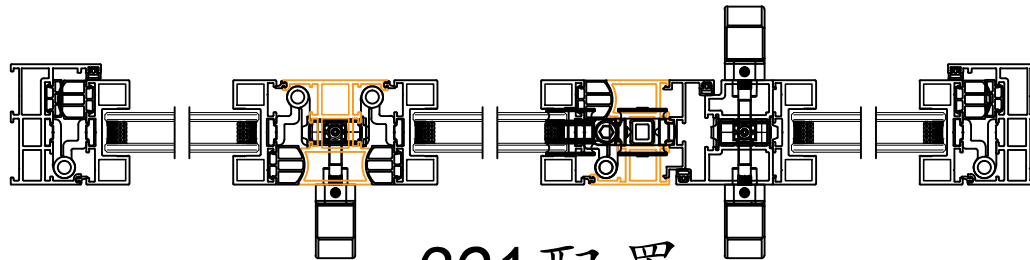

321配置

ZMD58A窄边折叠门系列

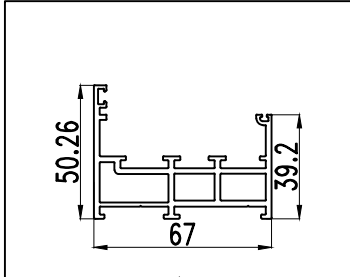

型号: ZDM58A01	名称: 外框
壁厚: 2.20 mm	重量: 1.593 kg/m

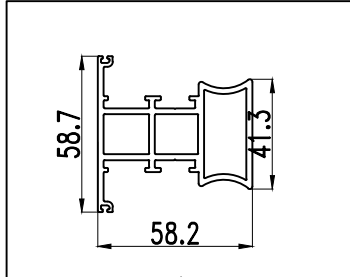

型号: ZDM58A02	名称: 中柱
壁厚: 2.20 mm	重量: 1.734 kg/m

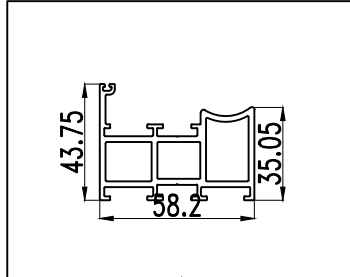

型号: ZDM58A03	名称: 半中柱
壁厚: 2.20 mm	重量: 1.523 kg/m

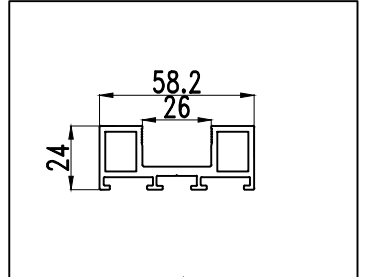

型号: ZDM58A04	名称: 扇料
壁厚: 2.20 mm	重量: 1.141 kg/m

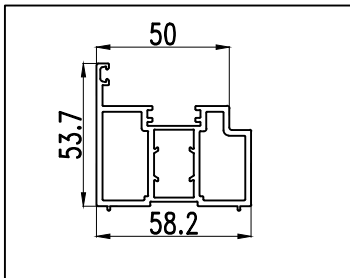

型号: ZDM58A05	名称: 收口
壁厚: 2.20 mm	重量: 1.613 kg/m

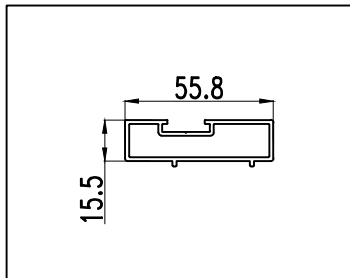

型号: ZDM58A06	名称: 外框收口
壁厚: 1.50 mm	重量: 0.622 kg/m

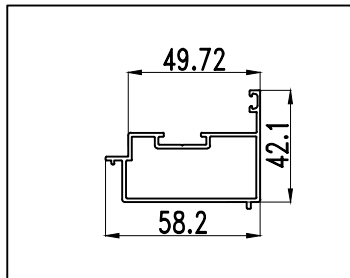

型号: ZDM58A07	名称: 外框收口
壁厚: 1.40 mm	重量: 0.751 kg/m

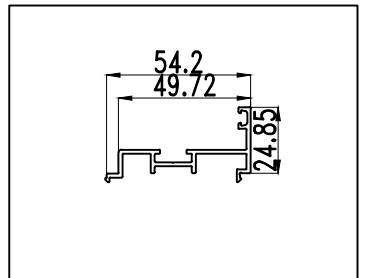

型号: ZDM58A08	名称: 收口
壁厚: 1.50 mm	重量: 0.489 kg/m

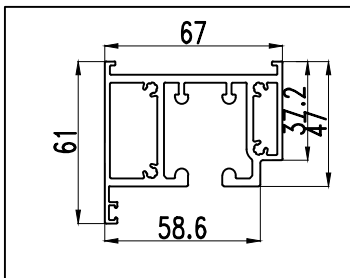

型号: ZDM58A10	名称: 上吊轨
壁厚: 2.00 mm	重量: 2.322 kg/m

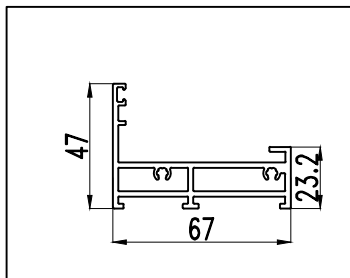

型号: ZDM58A11	名称: 下框料
壁厚: 2.00 mm	重量: 1.342 kg/m

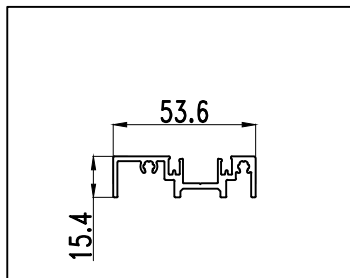

型号: ZDM58A12	名称: 下轨辅料
壁厚: 1.60 mm	重量: 0.678 kg/m

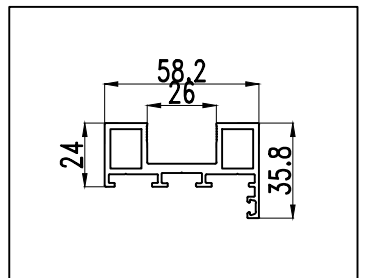

型号: ZDM58A13	名称: 横扇料
壁厚: 2.20 mm	重量: 1.213 kg/m